

Electrical Wiring Diagram

Typ	4602 AquaMaster AQ22/30/45I	Serial No.	Technik Elektro:	Checked	Date:	Checked by:
Marking	Function	Code	Size	Producer	Standard/Option	Serial
-CO1	reversing valve		230V	Wilspec	Option	
-I1	DC drive	PSD16200	1x230V	Carel/It	Yes	
-pCO5	controller	PCO5		Carel/It	Yes	
-PGD1	semigraphical display			Carel/It	Yes	
-pAD1..pAD11..pAD12	room terminal			Carel/It	Option	
-EK1	el. heater 4.5/6/6kW		3x230V	Baker/CZ	Option	
-ExV	EEV 18/18/24kW			Carel/It	Yes	
-EVO	EEV driver	EVDEvo	24V	Carel/It	Yes	
-F1	circuit breaker control		6A	Hager	Yes	
-F3, 31, 32	circuit breaker heater		20A	Hager	Yes	
-FU1	transformer fuse		1A		Yes	
-FU2	transformer fuse		2A		Yes	
-K3	compressor run relay		4xSPDT, 230V	Finder	Yes	
-K5	heater contactor		3x400V/25A, 40	AB	Yes	
-K51	heater contactor	ER120	2x230V/20A, 20	Hager	Yes	
-K6	heater contactor		3x400V/25A, 40	AB	Yes	
-K61	heater contactor	ER120	2x230V/20A, 20	Hager	Yes	
-K62	heater safety thermostat relay		4xSPDT, 230V	Finder	Yes	
-M1	compressor GKT141/GJT240/GPT425DBA		3x230V/BLDC	LG	Yes	
-M2	pump heating	HUPA/HEP	1x230V/50Hz	HALM	Yes	
-M3	pump brine	HUPA/KGPA	1x230V/50Hz	HALM	Yes	
-M10	SHW pump / 3 way valve		1x230V/1A		No	
-M11	pump heating circuit 1		1x230V/1A		No	
-M12	pump heating circuit 2		1x230V/1A		No	
-M111	mixing valve servo HC1		24VAC/0-10VDC		No	
-M121	mixing valve servo HC2		24VAC/0-10VDC		No	
-TC1	triac module	MCHRTF04C0	1x230V/4A	Carel/It	Yes	
-PB1	SHW probe		NTC10K	Carel/It	Yes	
-PB2	heating water probe		NTC10K	Carel/It	Yes	
-PB3	outdoor probe		NTC10K	Carel/It	Yes	
-PB4	water probe HC1		NTC10K	Carel/It	Yes	
-PB5	water probe HC2		NTC10K	Carel/It	Yes	
-PS1	SGT probe		NTC10K	Carel/It	Yes	
-PS2	DGT probe		NTC50K	Carel/It	Yes	
-PT1/LP	pressure transducer		SPKT33R0	Carel/It	Yes	
-PT2/HP	pressure transducer		SPKT00B6R0	Carel/It	Yes	
-Q1	drive circuit breaker		1x230V/25/25/32A"B"	Hager	Yes	
-S1	main switch		3x400V/63A		Yes	
-S3	high pressure switch		42bar	Danfoss	Yes	
-S4	flow switch		24VAC/1A	Sika	Option	
-T2	heater safety thermostat		70 °C	TG	Option	
-TR1	transformer		230VAC/22VAC/63VA		Yes	
-FB	fieldbus card	PCO100FD00		Carel/It	Yes	
-BMS	bms card	PCOS004850		Carel/It	Yes	
-ET1	internet module	NeoBOX		Neoware	Option	
N, PE	terminals 2x6mm ²				Yes	
L1..N..PE..1..96	terminals 2.5mm ²			Wago	Yes	

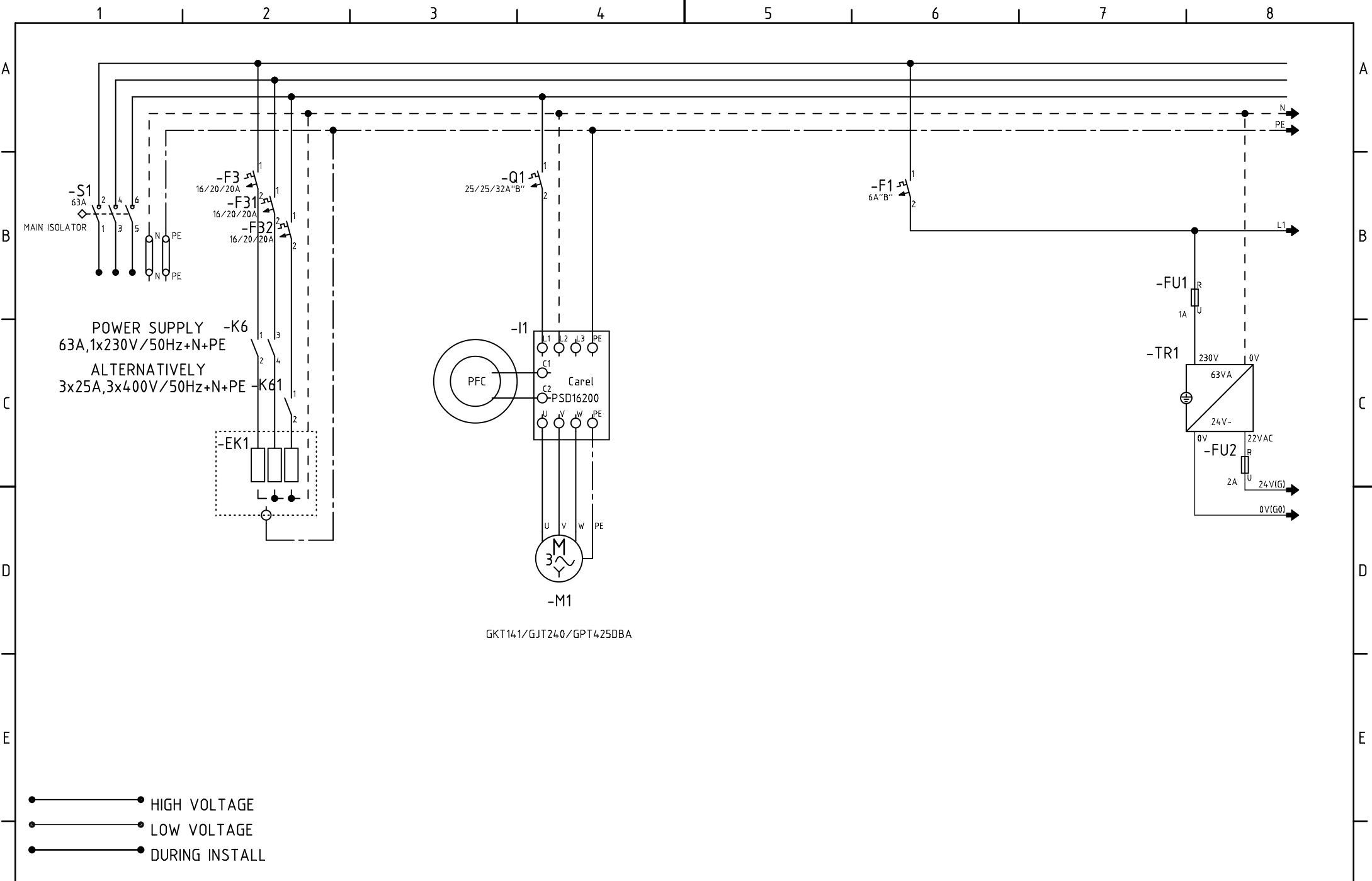

ECN No.	Date	Name

ATTENTION: THIS DOCUMENT CONTAINS PROPRIETARY DATA OF AUOCOTEC.
 NO DISCLOSURE, REPRODUCTION OR USE OF ANY PART OF THIS DOCUMENT MAY BE MADE WITHOUT WRITTEN PERMISSION.

A4
 Scale FULL

PRODUCT INDEX
Drawn by Ing. Jirka Jiranek
Date 19.05.2012
Checked
Date

TITLE
 AquaMaster AQ22/30/45I

BOXAIR		
Project AquaMaster	Print Date 21.05.2012	
CUSTOMERS DRAWING No 4602	-	
Dwg No. 4602/1	Sheet 1 of	Rev 00

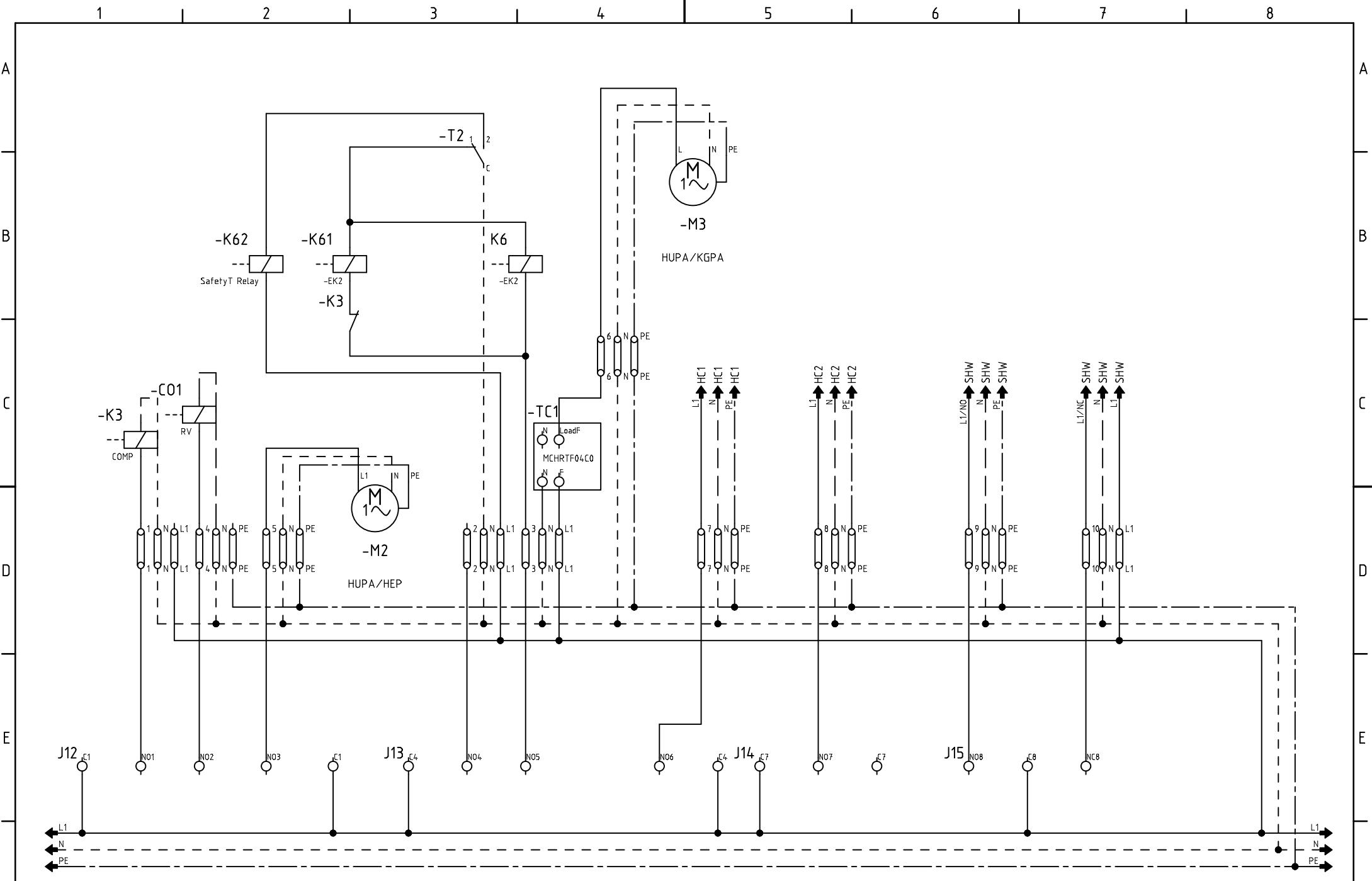

ECN No.	Date	Name

ATTENTION: THIS DOCUMENT CONTAINS PROPRIETARY DATA OF AUCOTEC.
 NO DISCLOSURE, REPRODUCTION OR USE OF ANY PART OF THIS DOCUMENT MAY BE MADE WITHOUT WRITTEN PERMISSION.

A3
 Scale FULL

PRODUCT INDEX	
Drawn by	Ing. Jirka Jiranek
Date	19052012
Checked	
Date	

TITLE
 AquaMaster AQ22/30/45I

Project	micro1	Print Date	22.05.2012
CUSTOMERS DRAWING No		4602	-
Dwg No.	4602/2	Sheet	1 of 00
Rev			

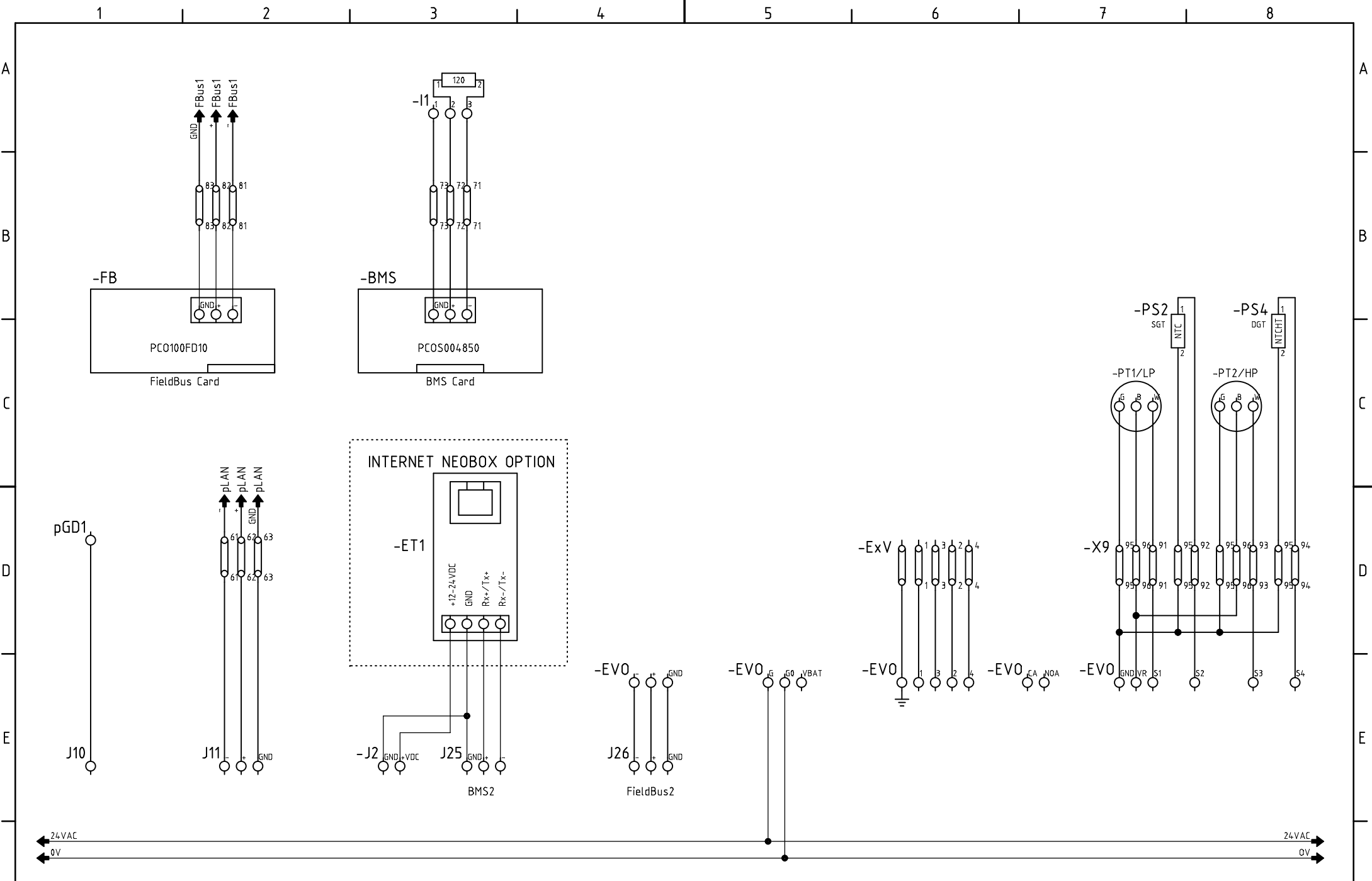

ATTENTION: THIS DOCUMENT CONTAINS PROPRIETARY DATA OF AUCOTEC.
 NO DISCLOSURE, REPRODUCTION OR USE OF ANY PART OF THIS DOCUMENT MAY BE MADE WITHOUT WRITTEN PERMISSION.

A4 Scale FULL	PRODUCT INDEX
	Drawn by
	Date 19052012
	Checked
Date	

TITLE	AquaMaster AQ22/30/45I
-------	------------------------

Project	micro1	Print Date	22.05.2012
3			
Drng No.	4602/4	Sheet	3 of 00
		Rev	00

POWER SUPPLY

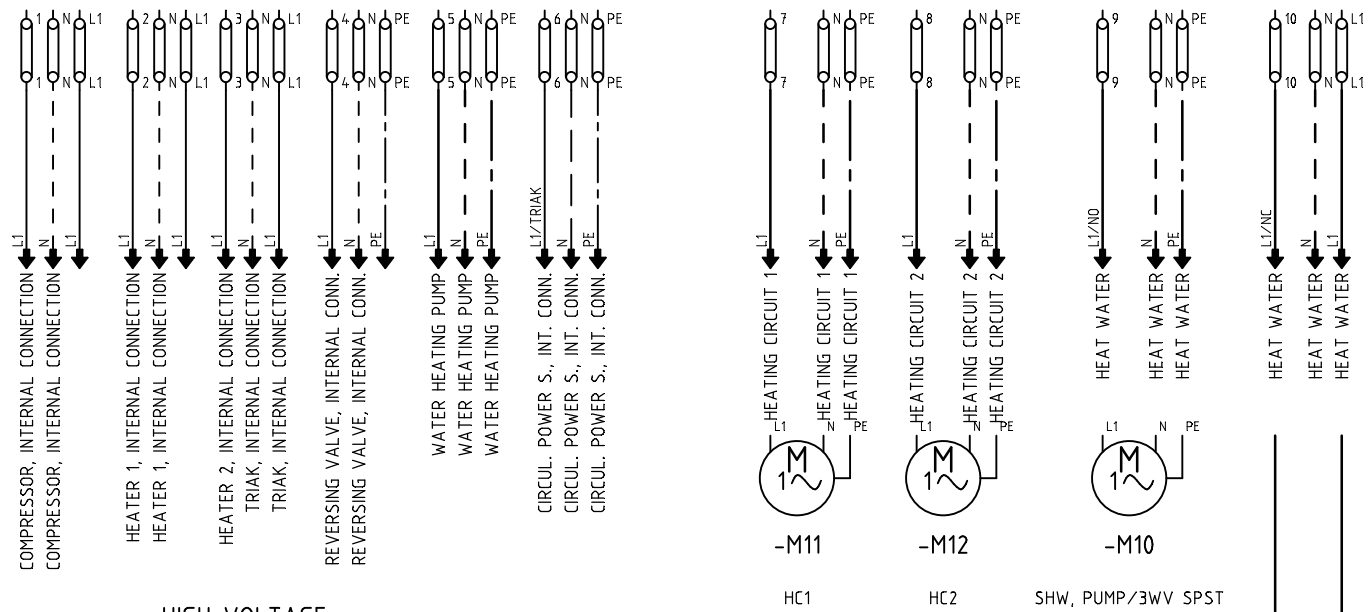
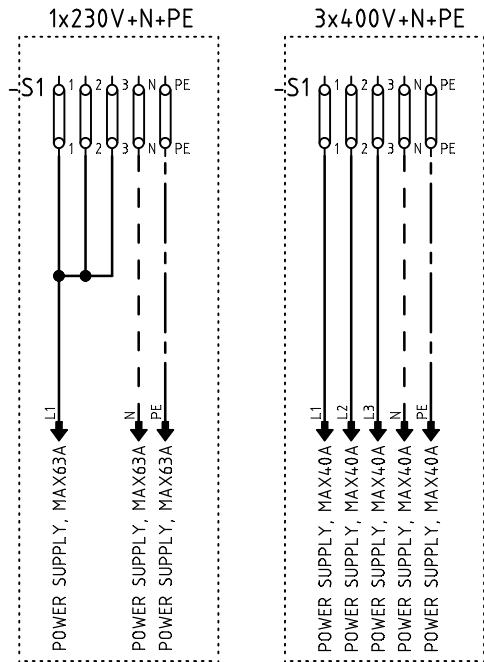

HIGH VOLTAGE

LOW VOLTAGE

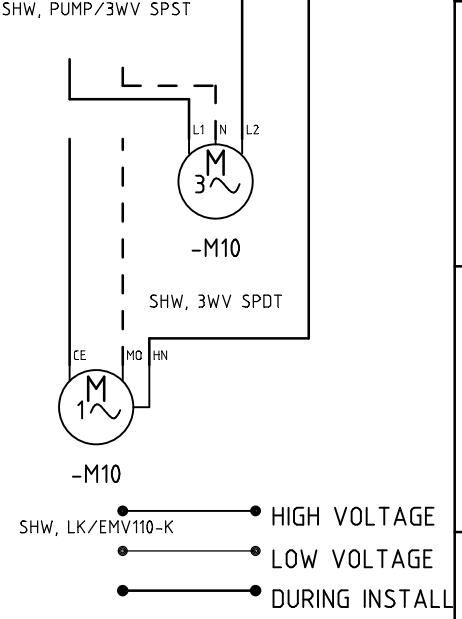
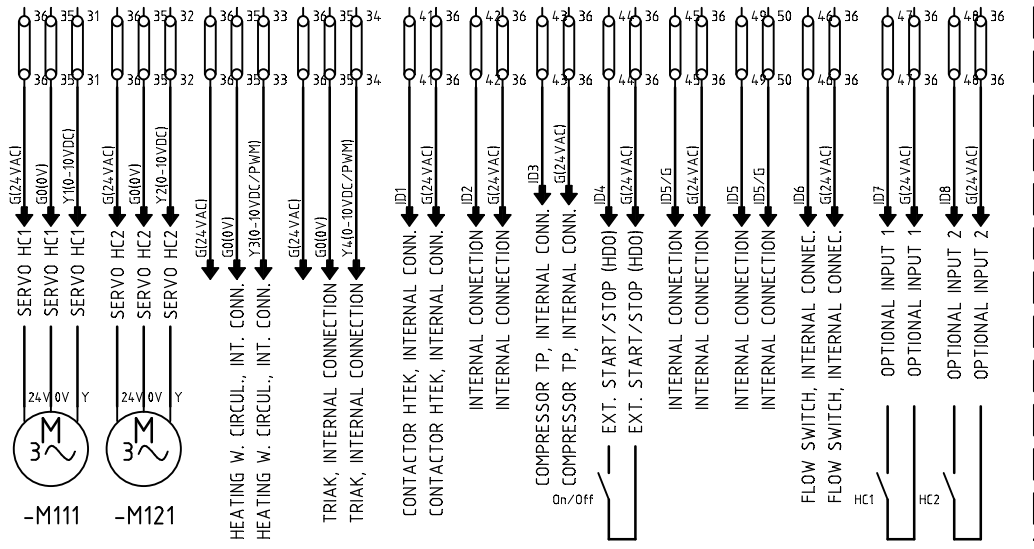
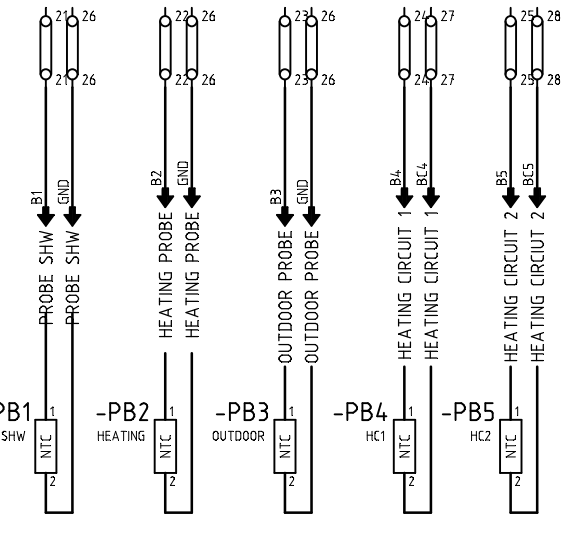

ECN No.	Date	Name

ATTENTION: THIS DOCUMENT CONTAINS PROPRIETARY DATA OF AUOCOTEC.
NO DISCLOSURE, REPRODUCTION OR USE OF ANY PART OF THIS DOCUMENT MAY BE MADE WITHOUT WRITTEN PERMISSION.

A4 Scale FULL	PRODUCT INDEX
	Drawn by Ing. Jirka Jiránek
	Date 19052012
	Checked Date

TITLE
AquaMaster AQ22/30/45I

AQUAMASTER		
Project AquaMaster	Print Date 22.05.2012	
2		
Drg No. 4602/5	Sheet 2 of	Rev 00

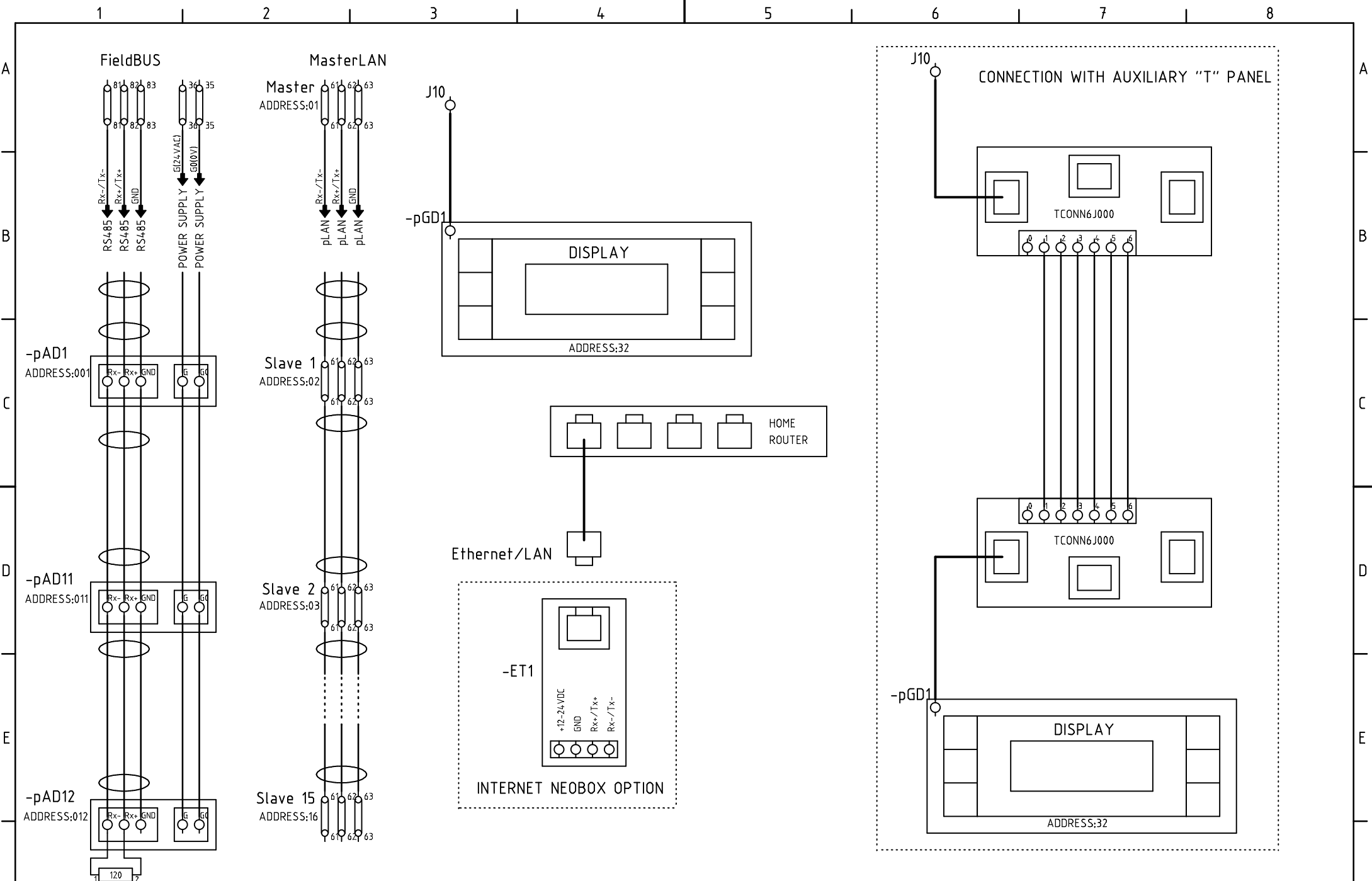

ECN No.	Date	Name

ATTENTION: THIS DOCUMENT CONTAINS PROPRIETARY DATA OF AUCOTEC.

NO DISCLOSURE, REPRODUCTION OR USE OF ANY PART OF THIS DOCUMENT MAY BE MADE WITHOUT WRITTEN PERMISSION.

A4 Scale FULL	PRODUCT INDEX
	Drawn by Ing. Jirka Jiranek
	Date 19052012
	Checked Ing. KAREL GUZEK

TITLE
AquaMaster AQ22/30/45I

Project	AquaMaster	Print Date	22.05.2012
Dwg No.	4602/6	Sheet	3 of 00
Rev			